

MOTORIDUTTORE TRAINO A SOFFITTO	60Kg – 120Kg
SPRINGS GARAGE MOTOR-REDUCER	60Kg – 120Kg
MOTEUR TRAÎNEAU Á PLAFOND	60Kg – 120Kg
MOTOR DE TECTO PARA PORTÕES SECC.	60Kg – 120Kg



**CARATTERISTICHE TECNICHE – CARACTÉRISTIQUES TECHNIQUE – TECHNICAL FEATURES –
CARACTERÍSTICAS TÉCNICAS**

	60Kg.	120Kg.
ALIMENTAZIONE – POWER SUPPLY ALIMENTATION – ALIMENTACION - ALIMENTAÇÃO	230Vac	
MOTORE ELETTRICO- ELECTRIC MOTOR- MOTEUR ELECTRIQUE- MOTOR ELÉCTRICO	24Vdc	
SPINTA-THRUST-POUSSEE-EMPUJE - FORÇA	60daN	120daN
ALTEZZA MAX PORTA-DOOR MAX HEIGHT- HAUTEUR MAXI PORTE-ALTURA MAX PUERTA ALTURA MÁXIMA DA PORTA SECCIONADA	3000mm	
ALTEZZA MAX PORTA SEZIONALE – SECTIONAL DOOR MAX HEIGHT- HAUTEUR MAXIME- PORTE SECTIONELLE- ALTURA MÁXIMA DA PORTA SECCIONADA	2700mm	
LARGHEZZA SEZIONALE MAX – MAX WIDTH OF SECTIONAL DOOR –LARGEUR MAXI PORTE SECTIONELLE-ANCHURA SECCIONAL MAX- LARGURA MÁXIMA DA PORTA SECCIONADA -	3000mm	4500mm
TEMPO APERTURA PORTA – DOOR OPENING TIME-TEMPS D'OUVERTURE PORTE- TIEMPO APERTURA PUERTA –TEMPO ABERTURA DA PORTA	20 sec	
PESO OPERATORE – OPERATOR WEIGHT POIDS OPERATEUR-PESO OPERADOR PESO DO MOTOR	6Kg	8Kg
DIMENSIONI OPERATORE-OPERATOR DIMENSIONS- DIMENSIONS OPERATEUR DIMENSIONES OPERADOS - DIMENSÕES DO MOTOR	340X170X h.150mm	
SICUREZZA-SAFETY-SÉCURITÉ –SEGURANÇA	DISPOSITIVO ANTISCHIACCIAMENTO ANTI-CRUSHING DEVICE / ANTIÉCRA- SEMENT / ANTI-ESMAGAMENTO	
RALLENTAMENTO – SOFT STOP – RALENTISSEMENT - ABRANDAMENTO	SI – YES- OUI	
CHIUSURA AUTOMATICA – AUTOMATIC RECLOSING –FERMATURE AUTOMATIQUE FECHO AUTOMÁTICO	SELEZIONABILE / SELECTABLE SELECTIONABLE /SELECCIONÁVEL	
LUCE DI CORTESIA-INTERNAL COURTESY LIGHT-LUMIERE DE COURTOISIE LUZ DE CORTESIA	24V / 20W	
SBLOCCO D'EMERGENZA-EMERGENCY UNLOCKING-DEBLOCAGE D'EMERGENCE DESBLOQUEO – DESBLOQUEIO DE EMERGÊNCIA	INTERNO-ESTERNO / INTERNAL- EXTERNAL / INTERIEUR-EXTERIEUR INTERNO-EXTERNO	
TRASCINAMENTO – DRIVE-ENTRAINEMENT- ARRASTRE - TRACÇÃO	A CATENA – CHAIN –CHAINE- CADENA POR CORRENTE	
FINECORSO – AUTOMATIC LIMIT SWITCH – FIN DE COURSE FIM DE CURSO – FINAL DE RECORRIDO	AUTOMATICO CON ENCODER AUTOMATIC MAGNETIC –AUTOMATIQUE AVEC LECTEUR MAGNETIQUE- AUTOM. CON DETECTOR MAGN. MECÁNICO/ENCODER	
LUNGHEZZA GUIDE / GUIDE LENGTH / LONGUEUR GUIDES /LONGITUD DE LAS GUIAS COMPRIMENTO DAS CALHAS	1500mm X 2 O 1000mm X3	

Per l'installazione attenersi alle norme antinfortunistiche UNI 8612 e CEI vigenti.
Prevedere in ogni caso un interruttore differenziale da 16A e soglia 0,030 A.
L'installazione dovrà essere effettuata solo da personale qualificato, in rispetto a
quanto previsto dalla legge n° 46 del 5 Marzo 1990 e successive modifiche ed interrogazioni.



Installation must comply with the current UNI 8612 and CEI accident prevention regulations.
In any case, provide a 16A differential switch with 0.030 A threshold. Installation must be carried out only
by qualified personnel, in compliance with the law No. 46 of March 5, 1990 and its successive
modifications and integration.



POUR L'INSTALLATION SUIVRE LES NORMES POUR LA PREVENTION DES ACCIDENTS UNI 8612
ET CEI EN VIGUEUR. PREVOIR DANS TOUS LES CAS UN INTERRUPTEUR DIFFERENTIEL DE 16A ET SEUIL 0.030 A.
L'INSTALLATION DEVRA ETRE EFFECTUEE SEULEMENT PAR UN PERSONNEL QUALIFIE, DANS LE RESPECT DE CE
QUI EST PREVU PAR LA LOI N° 46 DU 5 MARS 1990 ET LES MODIFICATIONS ET INTERROGATIONS SUCCESSIVES.



Para a instalação observar as normas UNI 8612 e CEI vigentes. Prever caso a caso um interruptor diferencial
de 16A de tensão de 0,030 A. A instalação deverá ser só efectuada por pessoal qualificado respeitando o
previsto na lei 46 de 5 de marco 1990 e sucessivas modificações e interrogações



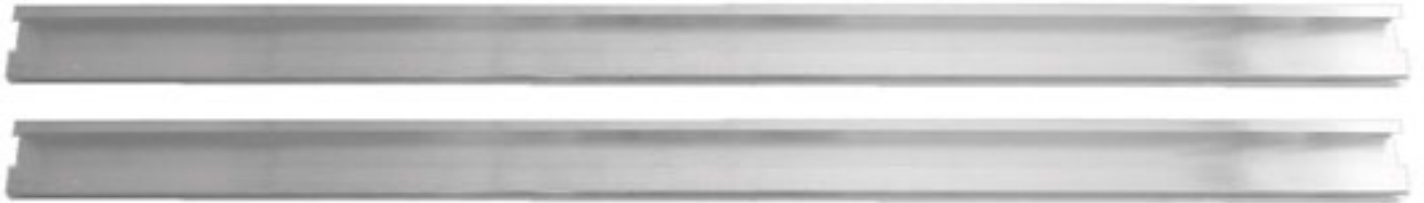

1

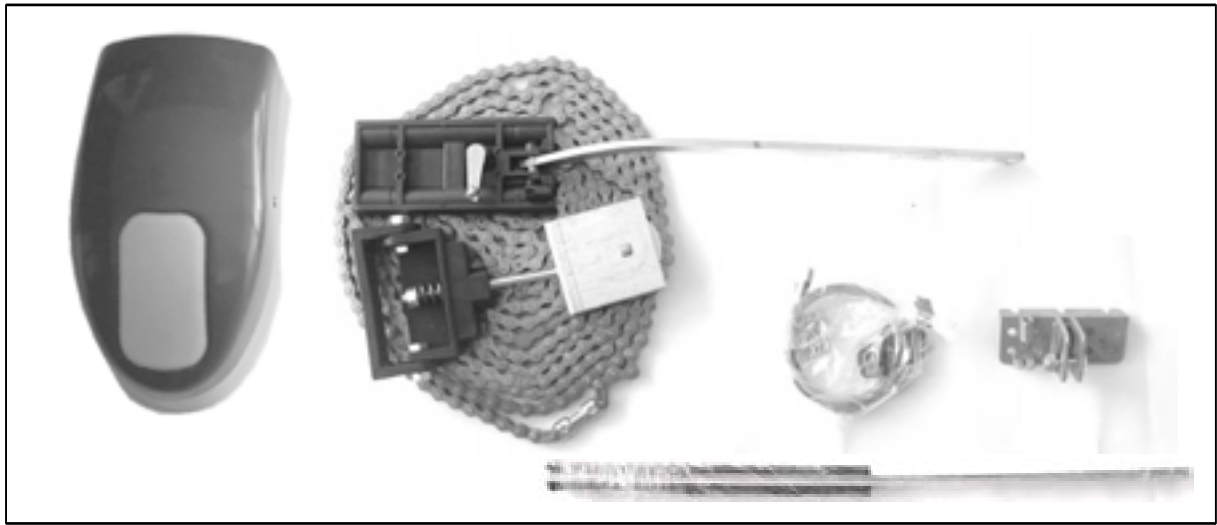

2



3

OPTIONAL
OPCIONAL

3 X

100 CM



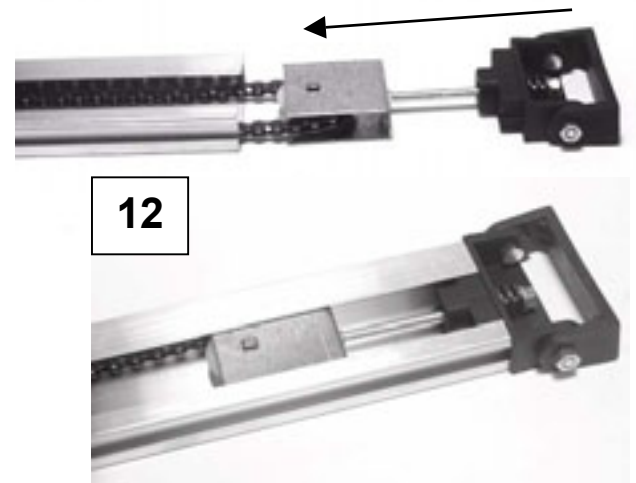
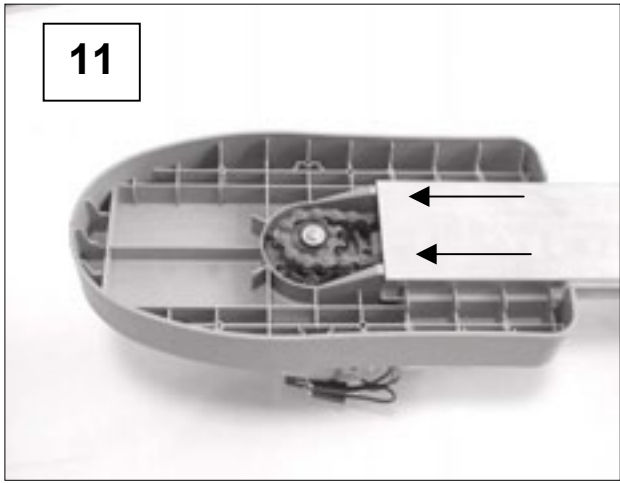
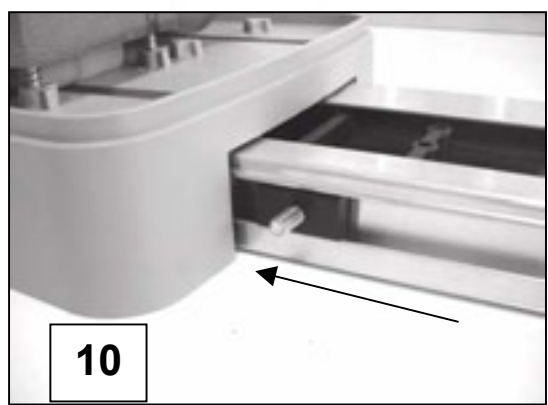
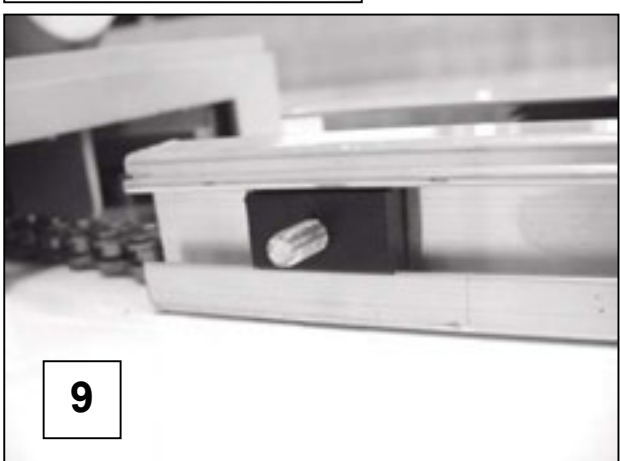
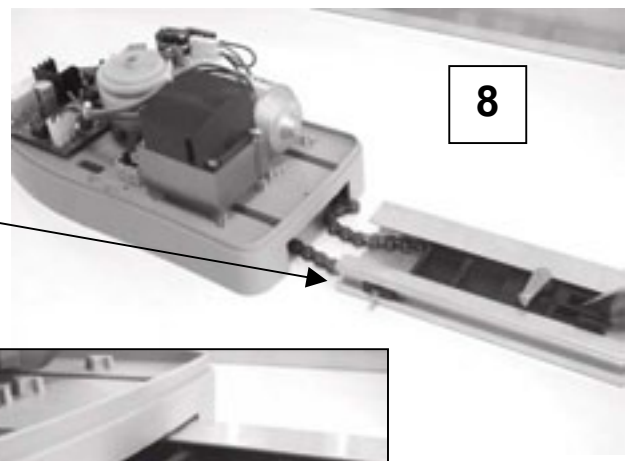
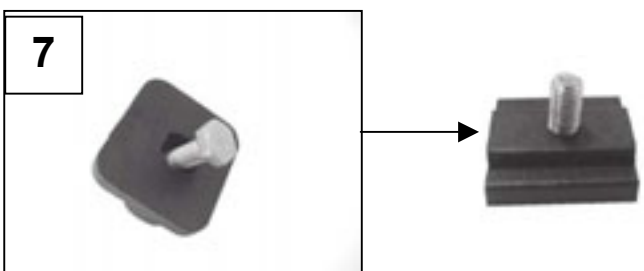
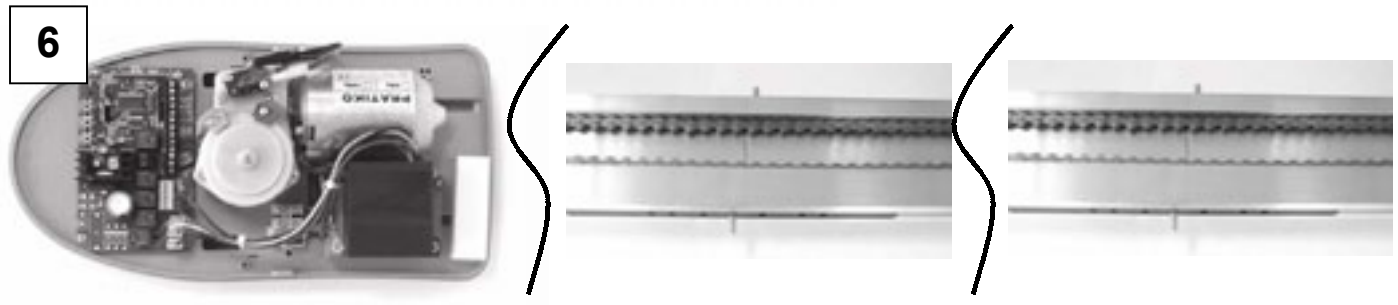
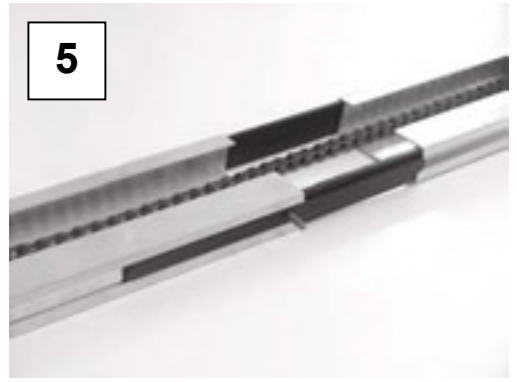
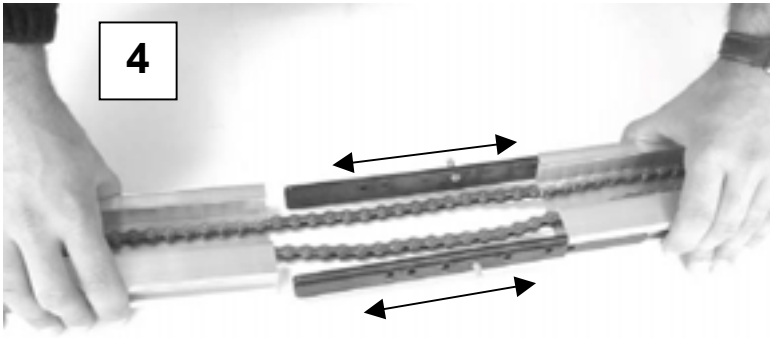

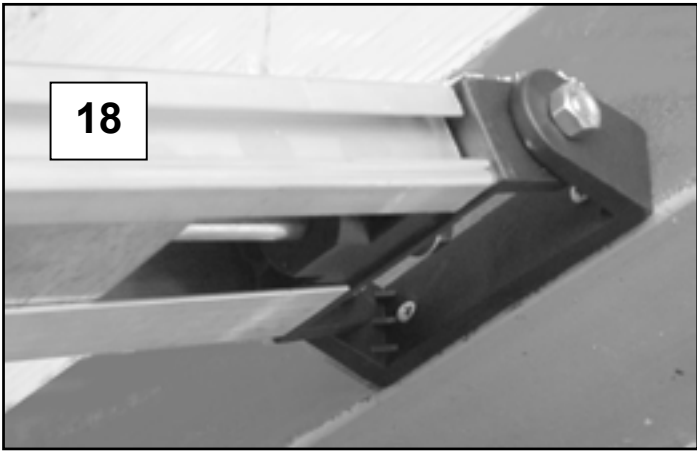
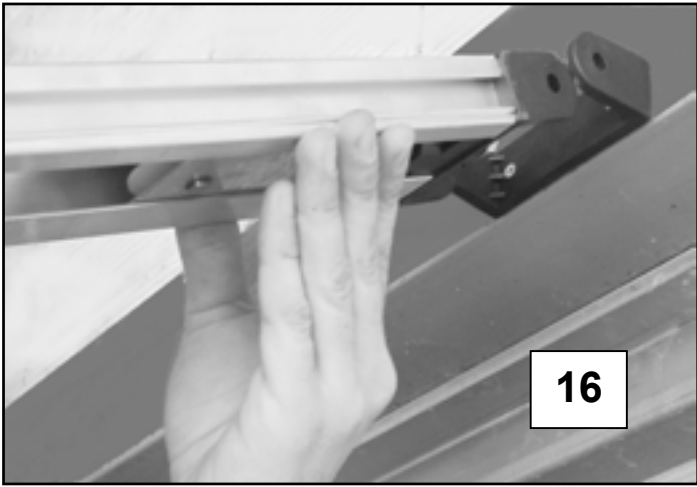
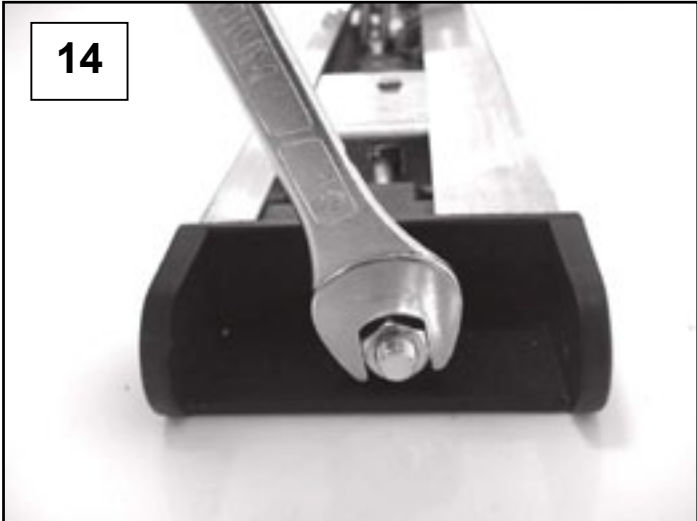
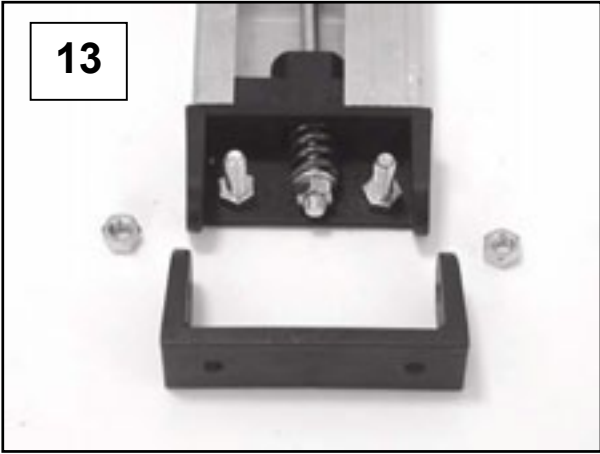

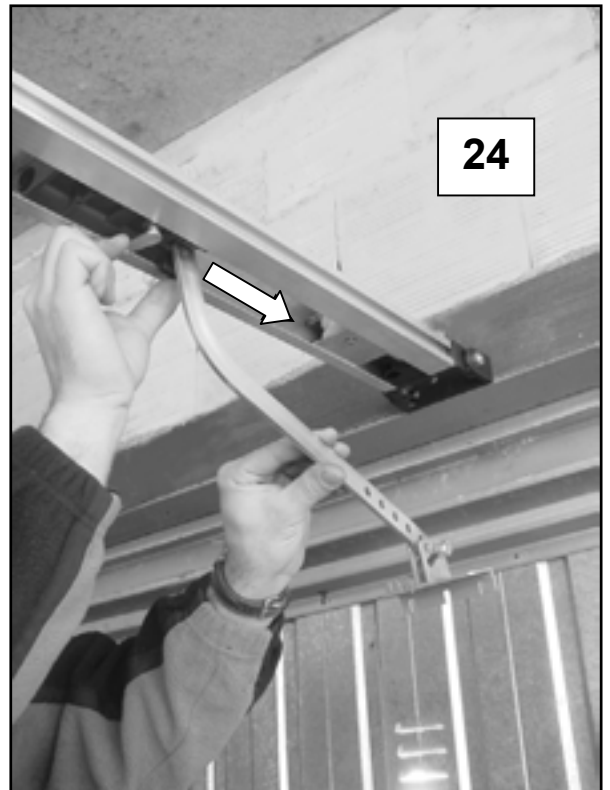
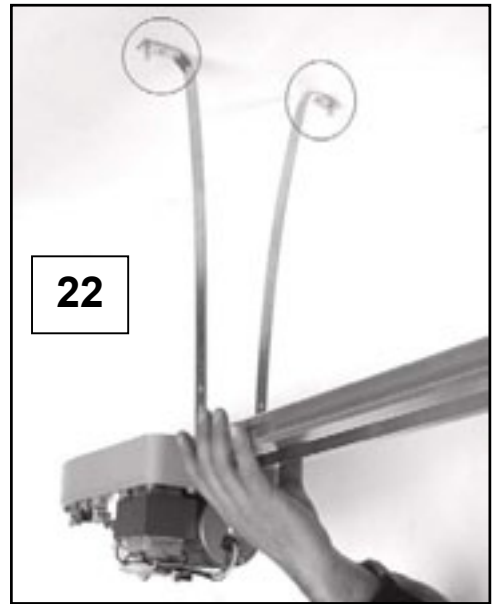
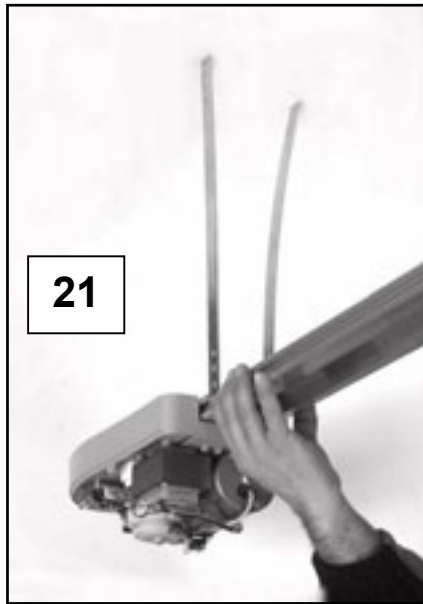
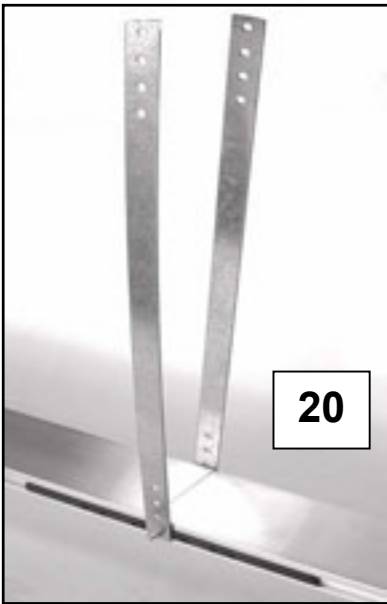

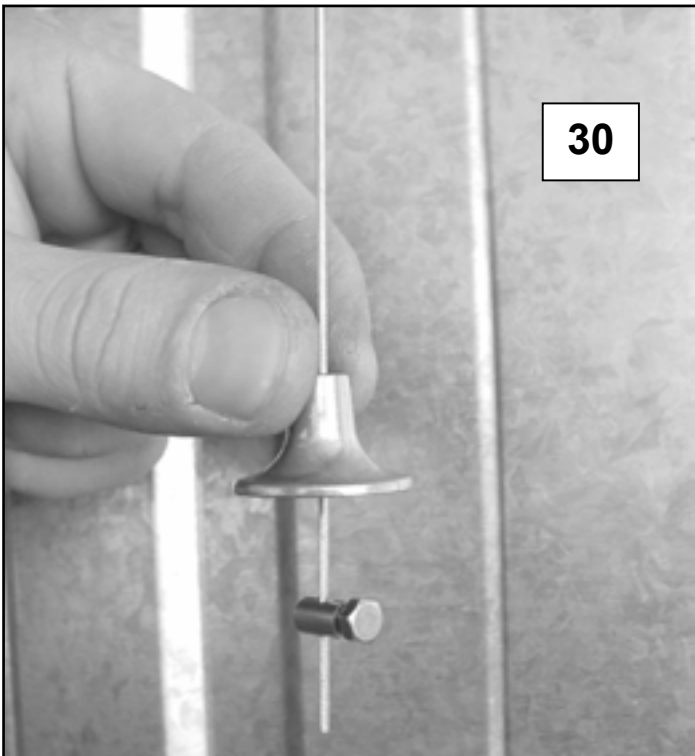
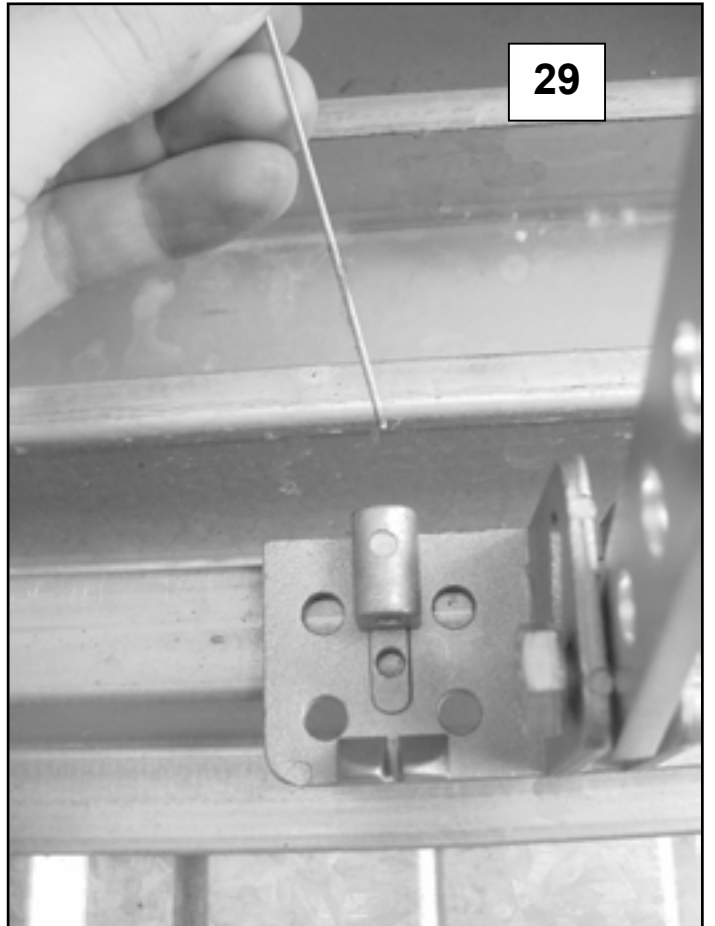
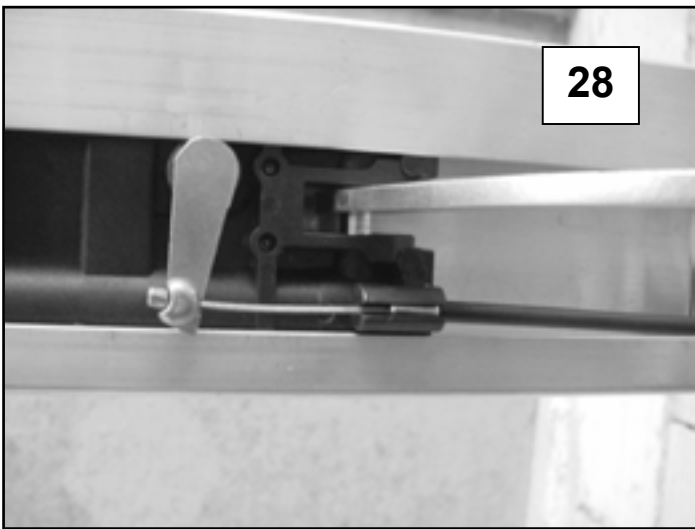
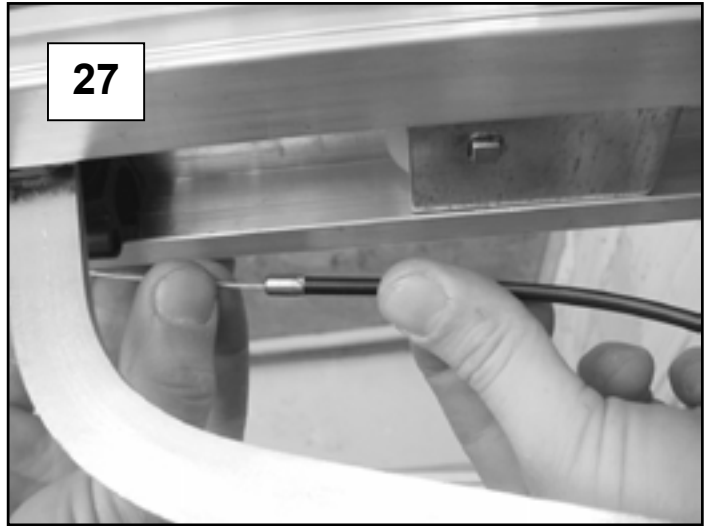
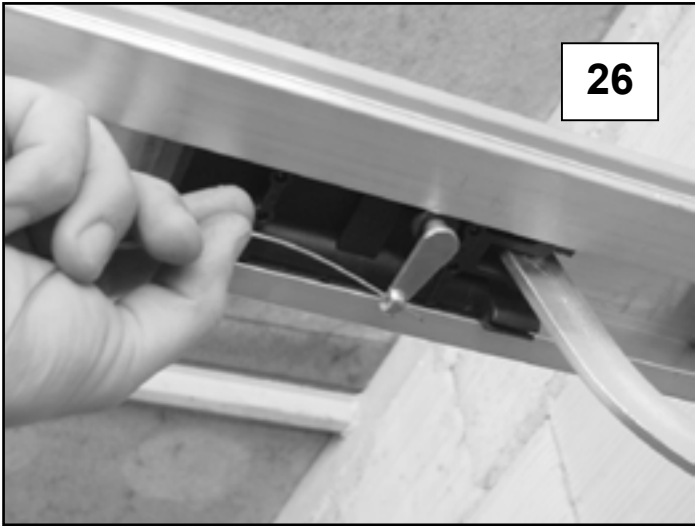

**OPTIONAL – SBLOCCO PERMANENTE / PERMANENT UNLOCK
DÉBLOCCAGE PERMANENT- DESBLOQUEIO PERMANENTE**

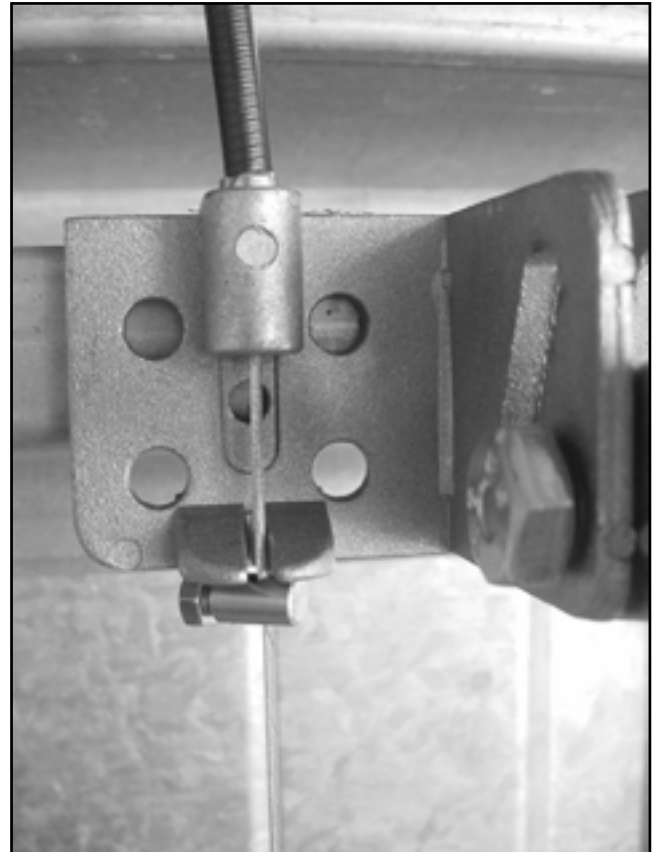
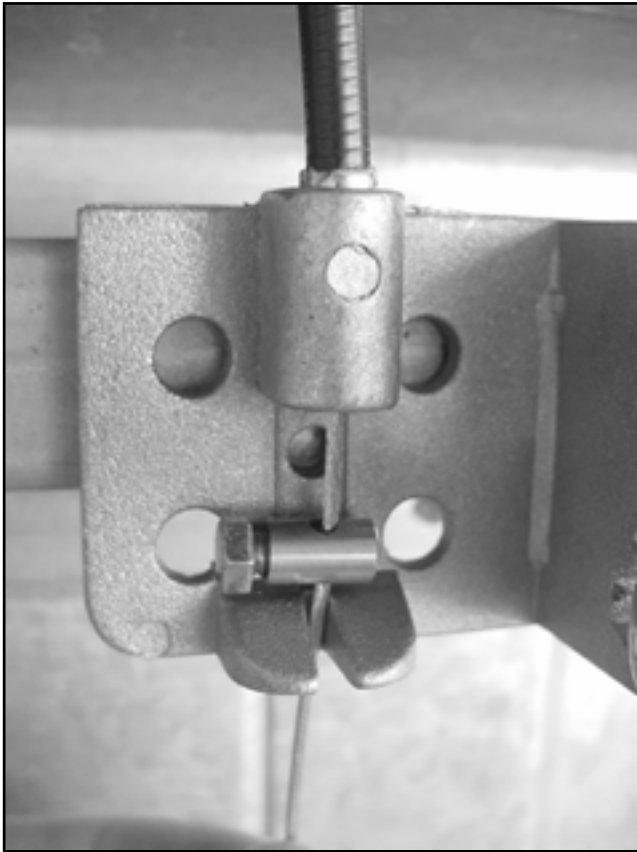

OPTIONAL

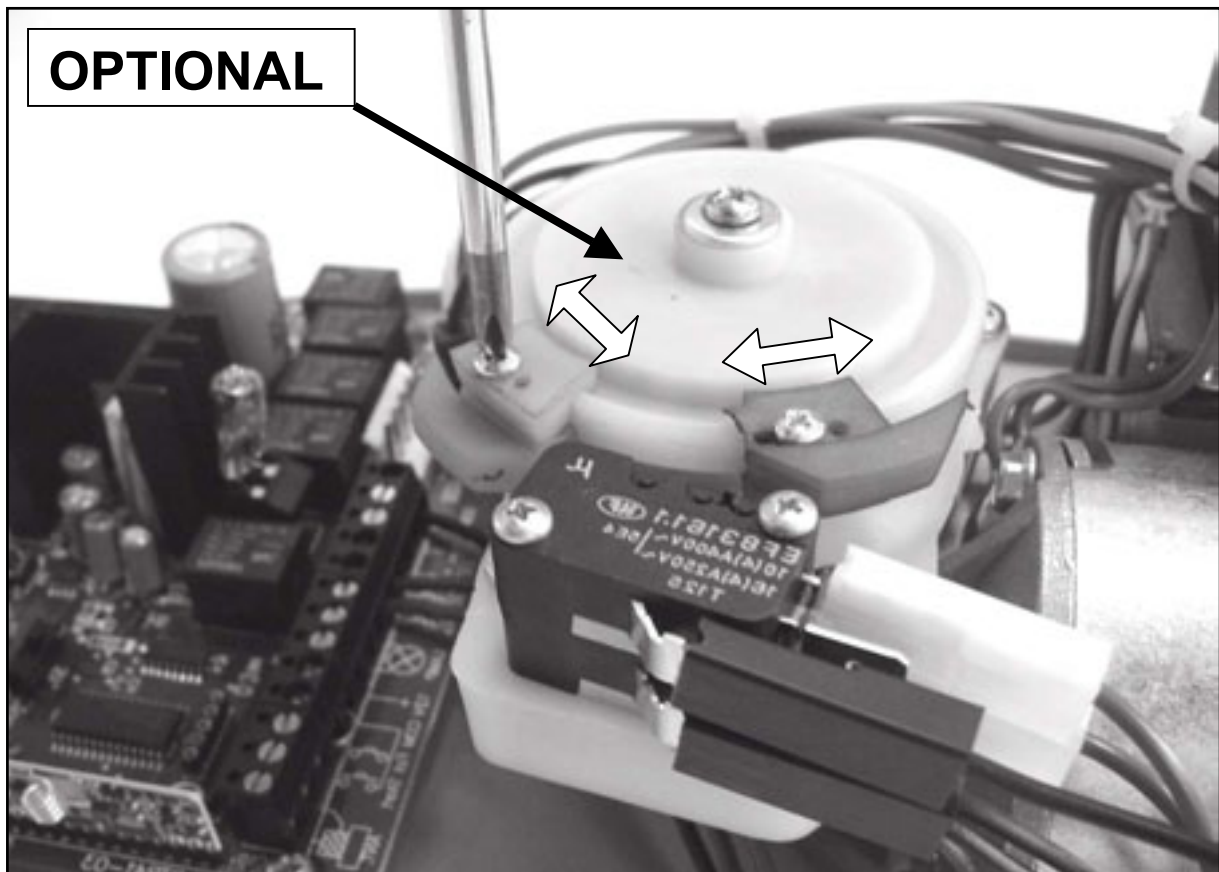

**SEZIONALE – SECCIONADA –
SECTIONAL**

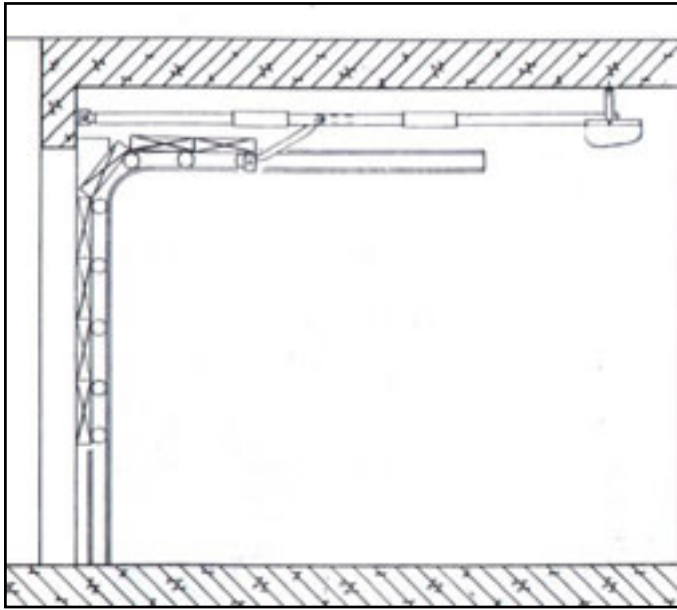

**A MOLLA – BASCULANTES –
A RESSORT - SPRING**

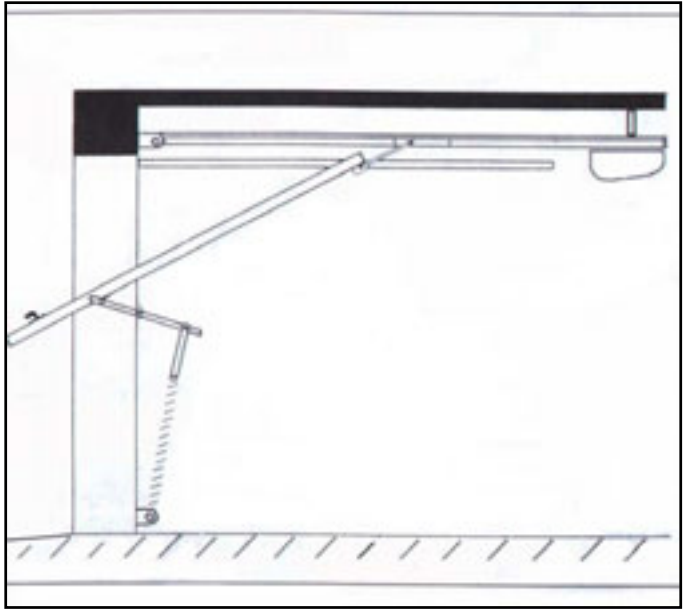

**A CONTRAPPESI – BASCULANTES DE
CONTRAPESOS - A CONTREPOIDS -
COUNTERWEIGHT**

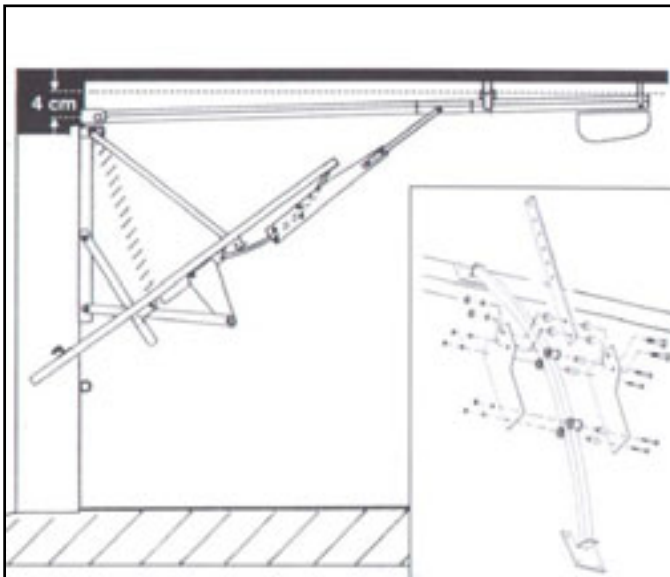

**OPTIONAL
OPTIONAL
OPTIONAL
OPCIONAL**

**NECESSARIO
NECESSARY
NECESSAIRE
NECESSÁRIO**





OPTIONAL

